

# 30 SERIES

# HC30WB2R1

# HC30WB5R1

2MP/5MP IP WDR IR Bullet Camera



## OPERATIONAL

Video Standard	NTSC/PAL
Scanning System	Progressive
Image Sensor	<b>HC30WB2R1:</b> 1/2.9" Progressive CMOS <b>HC30WB5R1:</b> 1/2.7" Progressive CMOS
Number Of Pixels (H × V)	<b>HC30WB2R1:</b> 1920(H) × 1080(V) <b>HC30WB5R1:</b> 2560(H) × 1920(V)
Minimum Illumination	<b>HC30WB2R1:</b> 0.065 lux color @ F2.0, 0 lux B/W with IR LEDs on @ F2.0 <b>HC30WB5R1:</b> 0.03 lux color @ F2.0, 0 lux B/W with IR LEDs on @ F2.0
S/N Ratio	> 55 dB
Electronic Shutter Speed	1/5 ~ 1/32,000
IR Distance	Distance up to 50m(165ft)
IR Light Control	Smart IR (Auto/Manual)/OFF
IR Light Number	2
Day/Night	Auto/Day/Night/Schedule
Backlight Compensation	WDR, HLC
White Balance	Auto/Fixed Current/Manual
Gain Control	0-100%
Wide Dynamic Range	120dB
Noise Reduction	3D DNR
Privacy Masking	Off / On (5 Areas)
Motion Detection	Motion/Intrusion/People detection
Tampering Detection	Tampering Detection/Image too dark detection/Image too bright detection/Image too blurry detection
Region Of Interest	Support
Lens	4.0mm, Fixed, F2.0
Angle Of View	<b>HC30WB2R1:</b> H:81°, V:44° <b>HC30WB5R1:</b> H:78°, V:59° @5M <b>HC30WB5R1:</b> H:82°, V:46° @4M

## VIDEO

Video Compression	H.265/H.264/Smart Codec/MJPEG
Resolution	<b>HC30WB2R1:</b> 1920×1080/1600×904/1360×768/ 1280×720/640×360; <b>HC30WB5R1 (5MP):</b> 2560×1920/2048×1536/ 1600×1200/1280×960/800× 600/640×480; <b>HC30WB5R1 (4MP):</b> 2688×1520/1920×1080/ 1600×904/1280×720/640×360
Frame Rate	<b>HC30WB2R1:</b> Main Stream: 1080P (1 ~ 25/30fps); Sub Stream: 720P (1 ~ 25/30fps); Third Stream: 640x360(1 ~ 25/30fps); <b>HC30WB5R1:</b> Main Stream: 5M/4M (1 ~ 25/30fps); *Up to 30fps @5M under H.265 only Sub Stream: 800x600 (1 ~ 25/30fps); Third Stream: VGA (1 ~ 25/30fps)

Bit Rate Control	Constrained bit rate/Fixed quality
Bit Rate	20K ~ 40Mbps

## NETWORK

Ethernet	10 Base-T/100 Base-TX Ethernet (RJ-45)
Supported Web Browsers	Chrome 71+, Internet Explorer 11.0+
Supported OS	Microsoft Windows 7/10
Protocols*	IPv4, IPv6, TCP/IP, HTTP, HTTPS, UPnP, RTSP/RTP/RTCP, IGMP, SMTP, DHCP, NTP, DNS, DDNS, CoS, QoS, SNMP, 802.1X, UDP, ICMP, ARP, TLS
Interoperability	ONVIF Profile G/S
Maximum Users Access	10 Users
Security	User account and password protection, HTTPS, IP Filter, Digest authentication, TLS1.2 only, Stream encryption, AES-128/256, SSH/ Telnet closed, PCIDSS compliance
Event	Event notification using HTTP, SMTP, NAS server and MicroSD card File upload via HTTP, SMTP, NAS server and MicroSD card
Micro SD	Micro SD/SDHC/SDXC card slot (256GB)

## ELECTRICAL

Power Supply	DC12V, PoE (IEEE 802.3af) (Class 2)
Power Consumption	MAX 6.49W

## MECHANICAL

Dimensions	ø91.1mm x 177mm (ø3.59" x 6.97")
Product Weight	0.53kg
Package Weight	0.74kg
Material	Die-casting aluminum housing with coating
Construction Color	RAL 120-1 (Lyric White)

## ENVIRONMENTAL

Operating Temperature	Starting: -10°C ~ 60°C (14°F ~ 140°F) Working: -30°C ~ 60°C (-22°F ~ 140°F)
Relative Humidity	Less than 90%, non-condensing
Ingress Protection	IP66

## REGULATORY



Emissions	FCC PART 15B, EN 55032, EN61000-6-3
Immunity	EN 50130-4
Safety	UL 62368-1, EN 62368-1
ROHS	EN 50581
Country of Origin	Taiwan

\*Some development may be required in specific user cases to support some of these protocols in the field as they mature over time.

**Honeywell**

# 30 SERIES 2MP/5MP IP WDR IR BULLET CAMERA

SYSTEM COMPATIBILITY	
MAXPRO NVR PE	Up to 128 IP channels RAID5/6 Enterprise NVR
MAXPRO NVR SE	Up to 64 IP channels System NVR
MAXPRO NVR XE	Up to 16 IP channels system NVR
MAXPRO NVR SOFTWARE	Up to 128 IP channels Recording Software
ADPRO NVR FASTTRACE 2E	Up to 32 IP channels with up to 32 VA channels NVRs, or Up to 20 Analogue channels Hybrids
ADPRO NVR IFT-E	Up to 32 IP channels with up to 32 VA channels NVRs
ADPRO NVR IFT	Up to 32 IP channels or 16 IP channels with up to 16 VA channels NVRs
ADPRO NVR EFT	Up to 16 IP channels with up to 8 VA channels NVRs, or Up to 16 Analogue channels Hybrids
ADPRO NVR IFT GATEWAY	4 IP channels + 4 VA channels
HEN*4	8/16/32/64-channel Performance Series NVRs (H.264 and H.265)
HEN*3	4/8/16-channel Performance Series NVRs (H.264 and H.265)

MOUNTS AND ACCESSORIES		
HBS2-BB		Junction Box
HQA-PM2		Pole Mount Adapter with HBS2-BB

ORDERING	
HC30WB2R1	2MP Network Bullet Camera, TDN, WDR, 1/2.9" CMOS, 4.0mm, 2 IR LEDs, H.265, PoE, IP66, NDAA Compliant
HC30WB5R1	5MP Network Bullet Camera, TDN, WDR, 1/2.7" CMOS, 4.0mm, 2 IR LEDs, H.265, PoE, IP66, NDAA Compliant

## DIMENSIONS

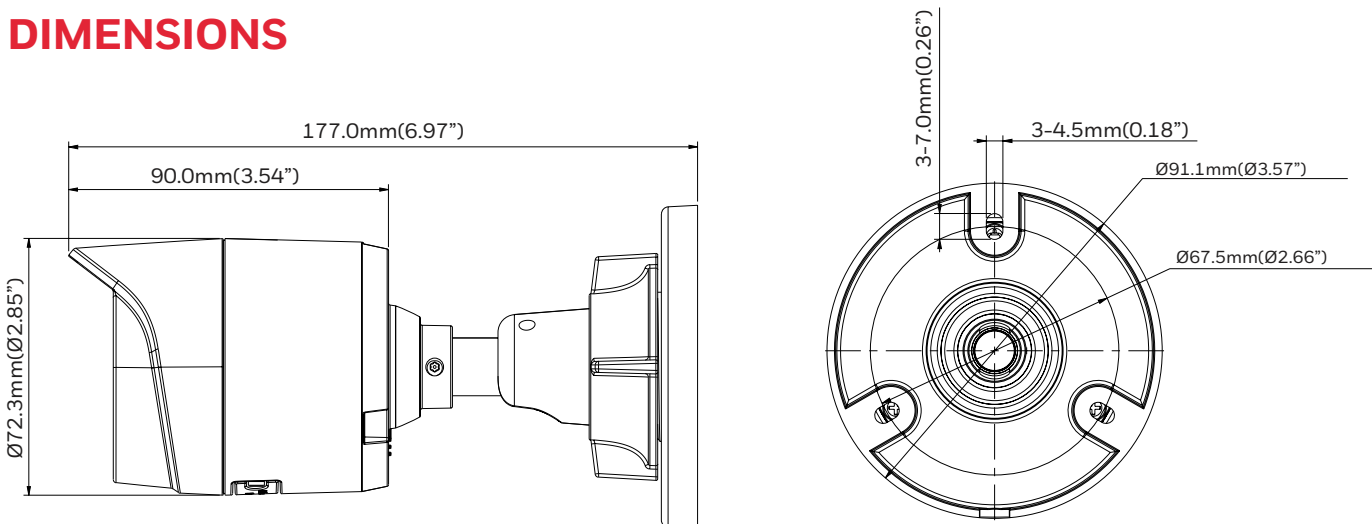

### For more information

[www.security.honeywell.com](http://www.security.honeywell.com)

### Honeywell Commercial Security

715 Peachtree St. NE  
 Atlanta, GA 30308  
 1.800.323.4576  
[www.honeywell.com](http://www.honeywell.com)

ONVIF and the ONVIF logo are trademarks of ONVIF Inc. Honeywell reserves the right, without notification, to make changes in product design or specifications.

HSV-HC30WBxR1-02-US(0619)DS-Z  
 © 2019 Honeywell International Inc.

THE  
 FUTURE  
 IS  
 WHAT  
 WE  
 MAKE IT

**Honeywell**